

# AL250

Aerial Light

User Manual

---

Fiilex

# Table of Contents

What's in the Box	1
Getting to Know your Light	3
Setup and Basic Operation	5
Specifications	9
For Your Safety	9
1 Year Limited Warranty	10

# What's in the Box

- AL250 (Light Body)
- Li-ion Rechargeable Battery

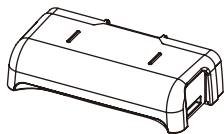
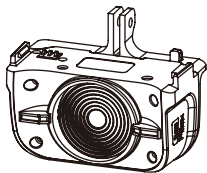

- Mounting Knob  
(GoPro Mount Compatible)

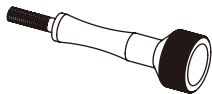

- Mounting Base  
(GoPro Mount Compatible)

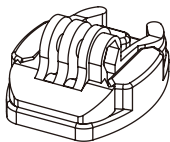

1

- USB Cable

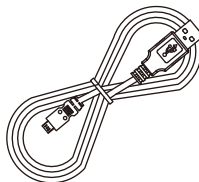

- Safety Lanyard

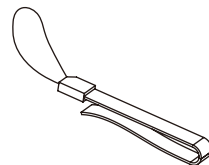

- Charger

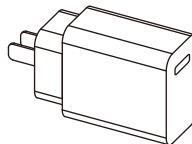

- Drawstring Bag



- User Manual

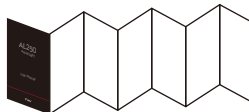

2

# Getting to Know your Light

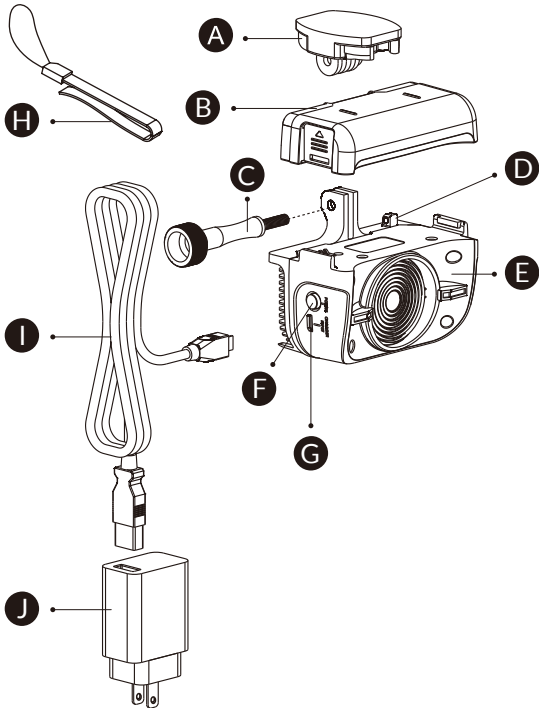

- A Mounting Base
- B Li-ion Rechargeable Battery
- C Mounting Knob
- D Hole for Safety Lanyard
- E AL250 (Light Body)
- F Power (Charge Indicator)
- G Charger Input
- H Safety Lanyard
- I USB Cable
- J Charger

# Setup and Basic Operation

## Removing Battery

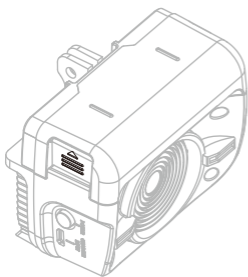

1. Press and hold battery release.

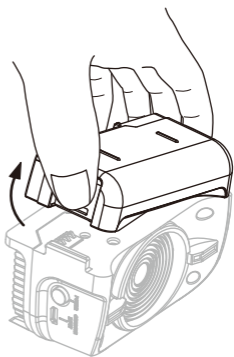

2. Separate battery from fixture.

## Install on the Drone \*

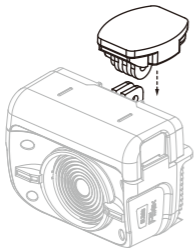

1. Attach the Mount Base (A) to the AL250.

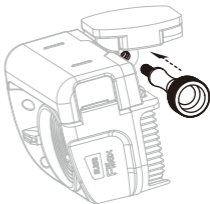

2. Insert the Mount Knob (C) into the Mount Base and tighten.

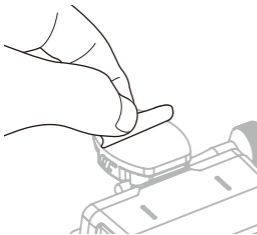

3. Tear away the sticker on the Mount Base (A).

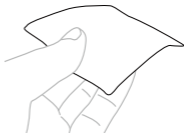
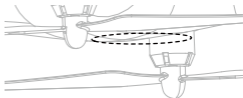

4. **IMPORTANT:** Clean attachment surface on bottom of drone with alcohol wipe to guarantee secure attachment.

\*Mount installation not necessary on drones with existing GoPro mounts.

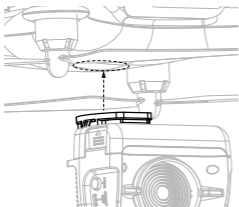

5. Stick the AL250 on the bottom of your drone.

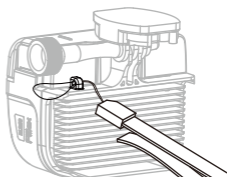

6. Fasten the Safety Lanyard (H) to the hole (D).



7. Secure the Safety Lanyard (H) onto the propeller arm.

## Charge

Insert the USB Cable (I) into the Charger Input (G) on the AL250. Plug the Power Charger into a standard AC wall outlet to charge.

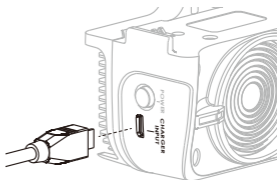

## Charge Indicator

While charging the battery, the Charge Indicator (F) on the AL250 turns red. It (F) turns green when the battery is fully charged.

Status	Indicator Light
Charging	● Red
Full-charge	● Green

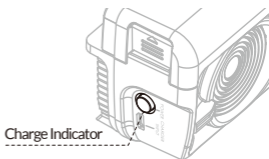

The Charge Indicator (F) will show the user the remaining charge of the battery with one of the following colors:

Status	Charge Indicator (Working Status)
100-40%	● Green
40-20%	● Orange
20-0%	● Red
Error	⚡ (Fast Blink 10 seconds - Off)

## Note

- \* AL250 will enter the Self Protection Mode when the heat sink is overheated (The light output will down to 30%).
- \* AL250 requires rechargeable Li-ion batteries. Use only Fiilex-approved batteries and chargers.
- \* You must fully charge the battery for first use. A discharged battery recharges fully in approximately 3 hours.
- \* For connection to an electrical supply outside the U.S., the proper adapter must be used for the power outlet. Use of the wrong adapter and/or power configuration could result in damage to the AL250 and void the warranty.



# Specifications

Size 3.7" (Length) × 2.9" (Width) × 2.1" (Height)

Weight 0.59 lb/ 270 g

20Wh (Watt hours)

2600mAh Power Capacity

Charger (Port Type) 5V/2A (Micro USB)

CCT 5600K

CRI ≥93

Battery Li-ion Rechargeable Battery 2600mAh

Operating Temperature 0 to 40 °C

# For Your Safety

- Do not remove Battery from AL250 when power is on.
- Do not attempt to disassemble the body of AL250.
- Do not install AL250 in a damp or wet area.
- Use only the included power supply.
- Use only a soft, dry towel to gently clean the exterior of the AL250.
- Do not attempt to disassemble, deform, solder, or heat battery.
- Do not insert battery with different connector.
- Stop using if battery expands or the temperature is over 40 °C (104 F) or under 0 °C (32 F).
- Do not short circuit battery.
- Do not leave AL250 inside a hot vehicle or trunk. Avoid using AL250 in direct sunlight for prolonged amounts of time.
- If batteries will not be used for an extended length of time, they should be fully discharged, sealed in a plastic bag, and stored in a refrigerator.
- Never leave a battery operated device unattended while it is running.

# 1 Year Limited Warranty

Unless otherwise stated, your product is covered by a one year parts and labor limited warranty. Fiilex guarantees, to the original buyer, that this product (Battery Not Included) is to be free of defects in both workmanship and material for a period of one year from the date of shipment. This warranty extends to all products (Battery Not Included) which have proved defective through normal use but excludes products that have been disassembled, modified or misused by the buyer or any other person. This warranty is in lieu of all other warranties, and disclaims all warranties expressed or implied, including any warranty of merchantability, fitness for a particular purpose, or arising from the course of dealing between the parties or usage of trade.

## Returning an Item Under Warranty for Repair

It is necessary to obtain a Return Merchandise Authorization Number (RMA#) from your dealer / point of purchase BEFORE any units are returned for repair. Fiilex will make the final determination as to whether or not the unit is covered by warranty. Fiilex will replace or repair to proper working condition any products that are returned under warranty. Products repaired or replaced under warranty are under warranty only for the remaining unexpired period of time of the original warranty.

Any product unit or part returned to Fiilex must be packaged in a suitable manner to ensure the protection of such product unit or

parts. The package must be clearly and prominently marked to indicate that the package contains returned product units or parts with a Return Merchandise Authorization Number(RMA#). All returned product units or parts must be accompanied by a written explanation of the alleged problem or malfunction.

**Fiilex**

Fiilex.com

1689 Regatta Blvd. Richmond, CA 94804

(510) 620-5155 . Fiilex@Fiilex.com

Information and Specifications in this document are subject to change without notice. DiCon Lighting, Inc. assumes no responsibility or liability for any error or inaccuracies that may appear in this manual. Unlawful reproduction or distribution in any manner without the written permission of DiCon Lighting, is strictly prohibited.

© DiCon Lighting 1996-2016 All Rights Reserved